

IC ULTRA High Mast

The IC Ultra high mast delivers powerful illuminance, equipped with well-designed optics for precise light distribution to cover large areas.

This Big Shine LED fixture carries a lens made with high-quality PC material and dispenses a transmittance rate of more than 90%.

Each LED module is rotatable and equipped with respirators to eliminate water vapor, allowing for optimal performance in various weather conditions.

APPLICATIONS

Industrial, Commercial, Recreational



DIMENSIONS

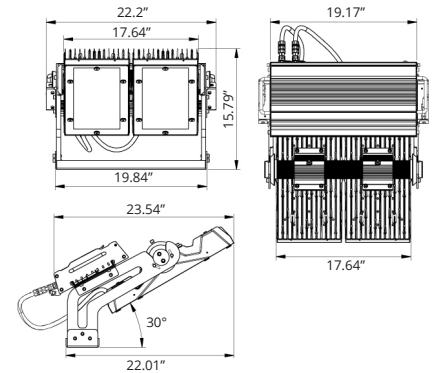

MODEL OPTIONS

Manufacturer	Fixture Type	Wattage	Voltage	Name	Driver	Chip	CCT (X)	Beam Angle (Y)
BSL BIG SHINE LED	HM High Mast	600W	100-277V G-277-480V Optional	ICU	MW Mean Well	NI Nichia	3000k, 4000K, 5000K	65x120°, 30x55°, 60x110°, 20°, 30°, 60°

TECHNICAL SPECIFICATIONS

	600W
Lumens	75,000
Efficacy	125
CRI	70 (5000K)
Voltage Input	100-277V
Voltage Output	48V
Amperage	6
Hertz	50-60 Hz
Total Harmonic Dist.	<15%
Control Options	0-10V Optional (T)
Operating Temp.	-22~122°F
IP Rating	IP66
IK Level	IK08
Weight	63.93 lb
Drive Life	50,000 hrs
L70 Results ¹	60,000 hrs

¹ LM80 and TM21 results are available upon request. Specifications are subject to change without notice.

FIELD & BEAM ANGLES

MODEL	Beam	Height vs. Illuminance (ft vs. lx)		
	Angle	9.8 ft	19.7 ft	29.5 ft
BSL-HM600-ICU-MWNI-5000K-65x120	65x120	3,202.1	800.5	355.8
BSL-HM600-ICU-MWNI-5000K-30x55	30x55	8,210.3	2,052.6	912.3
BSL-HM600-ICU-MWNI-5000K-60x110	60x110	2,562.7	640.7	284.7
BSL-HM600-ICU-MWNI-5000K-20	20	42,865.0	10,716.3	4,762.8
BSL-HM600-ICU-MWNI-5000K-30	30	25,422.7	6,355.7	2,824.8
BSL-HM600-ICU-MWNI-5000K-60	60	10,498.7	2,624.7	1,166.5

PHOTOMETRICS

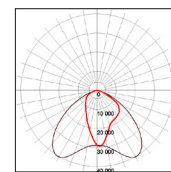

600W-5000K-65x120°

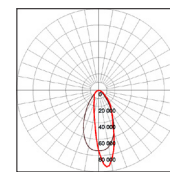

600W-5000K-30x55°

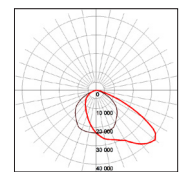

600W-5000K-60x110°

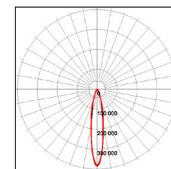

600W-5000K-20°

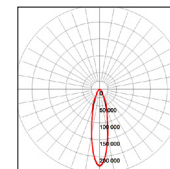

600W-5000K-30°

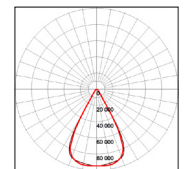

600W-5000K-60°

MOUNTING OPTIONS

Yoke Bracket

STANDARD COLOR OPTIONS



Black

*Customized colors available upon RAL request. MOQ applies.



IP66

