

Back-Lit LED Panel

Big Shine's affordable Back-Lite Panels can brighten up any office space and help you stay within budget. These quality fixtures are available in both 2 x 2 and 2 x 4 sizes, feature a CRI of 80, 0-10V dimming, and a frosted acrylic cover for soft, glare-free light. Choose from either 4000K, the popular choice for offices and schools, or 5000K if you prefer a cool white color temperature.

APPLICATIONS

Commercial



DIMENSIONS

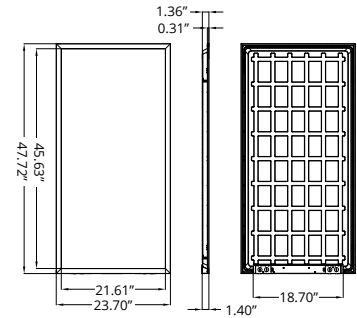

MODEL OPTIONS

Manufacturer	Fixture Type	Wattage	Voltage	Name	Driver	Chip	CCT (X)	Beam Angle (Y)
BSL BIG SHINE LED	PL Panel Light	40W	100-277V	2X4	BS Big Shine Driver	JF Jufei	3500K, 4000K, 5000K	120°

TECHNICAL SPECIFICATIONS

	40W
Lumens	5,120
Efficacy	128
CRI	82 (5000K)
Voltage Input	120-277V
Voltage Output	40-48V
Amperage	0.78
Hertz	50-60 Hz
Total Harmonic Dist.	15.4%
Control Options	0-10V Optional (T)
Operating Temp.	-4°~113°F
IP Rating	IP20
IK Level	IK05
Weight	9.67 lb
Driver Life	50,000 hrs
L70 Results ¹	50,000 hrs

¹ LM80 and TM21 results are available upon request. Specifications are subject to change without notice.

FIELD & BEAM ANGLES

MODEL	Beam	Height vs. Illuminance (ft vs. lx)		
	Angle	9.8 ft	19.7 ft	29.5 ft
BSL-PL40-2x4-BSJF-3500K-120	120	191.2	47.8	21.3

PHOTOMETRICS

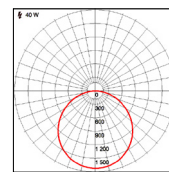

2X4 40W-3500K-120

MOUNTING OPTIONS

Recessed, Suspended, Flush

STANDARD COLOR OPTIONS

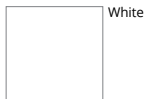

White

