

# ALMA Stairwell

Alma is the perfect solution for lighting common areas such as stairwells and hallways, which are only occupied intermittently. Alma's built-in microwave occupancy sensor provides outstanding energy savings with bi-level control. The moment a person enters the detection zone, Alma increases to a pre-set high power, providing visual comfort and safety to residents with bright but diffuse LED light. After the person exits, Alma pauses for a settable time delay, then self-dims to a low level.

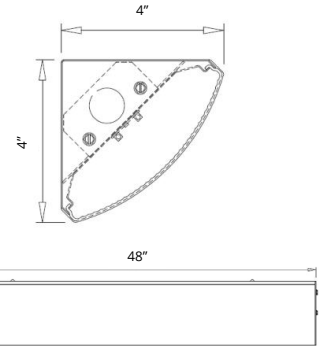

## DIMENSIONS



## APPLICATIONS

Stairwell and Passageway Luminaire

## MODEL OPTIONS

Manufacturer	Fixture Type	Wattage	Voltage	Name	Driver	Chip	CCT	Beam Angle
BSL BIG SHINE LED	SW Stairwell	40W (4FT)	120-277V G-277-480V Optional	AM4	YG YI Guang	SN San'an	3000K,4000K, 5000K	110°

## TECHNICAL SPECIFICATIONS

	40W
Lumens	4,800
Efficacy	120
CRI	82 (3000K)
Voltage Input	100-277V
Voltage Output	12V-56V
Amperage	0.347
Hertz	50-60 Hz
Total Harmonic Dist.	15.9%
Control Options	0-10V Optional (T)
Operating Temp.	-4°~113°F
IP Rating	IP40
IK Level	IK08
Weight	7.17 lb
Driver Life	50,000 hrs
L70 Results <sup>1</sup>	50,000 hrs

<sup>1</sup> LM80 and TM21 results are available upon request. Specifications are subject to change without notice.

## FIELD & BEAM ANGLES

MODEL	Beam	Height vs. Illuminance (ft vs. lx)		
	Angle	9.8 ft	19.7 ft	29.5 ft
BSL-SW40-AM4-YGSN-3000K-110	110	175.1	43.8	19.5

## PHOTOMETRICS

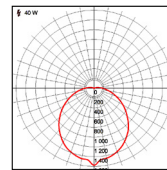

40W-3000K-110°

## MOUNTING OPTIONS

Wall Mount, Suspended Mount

## STANDARD COLOR OPTIONS

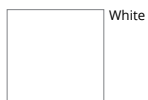

White

